

LN240(30)M-3-xxx(250-270W MONO)

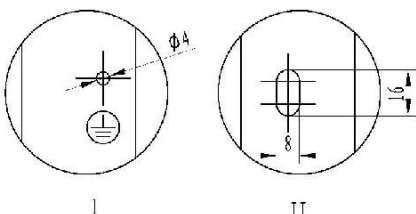

Secured Premium Quality:

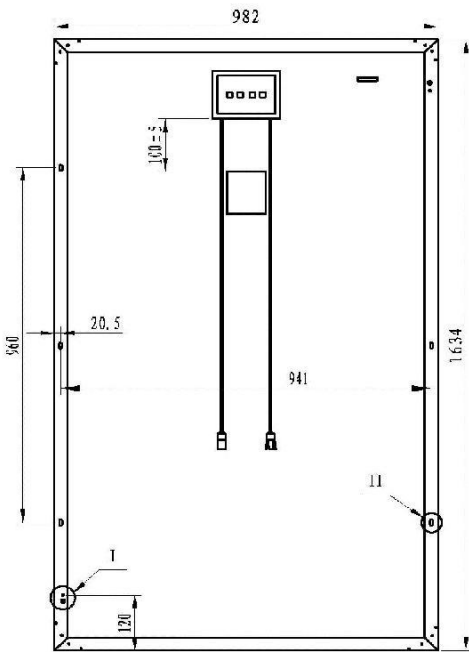
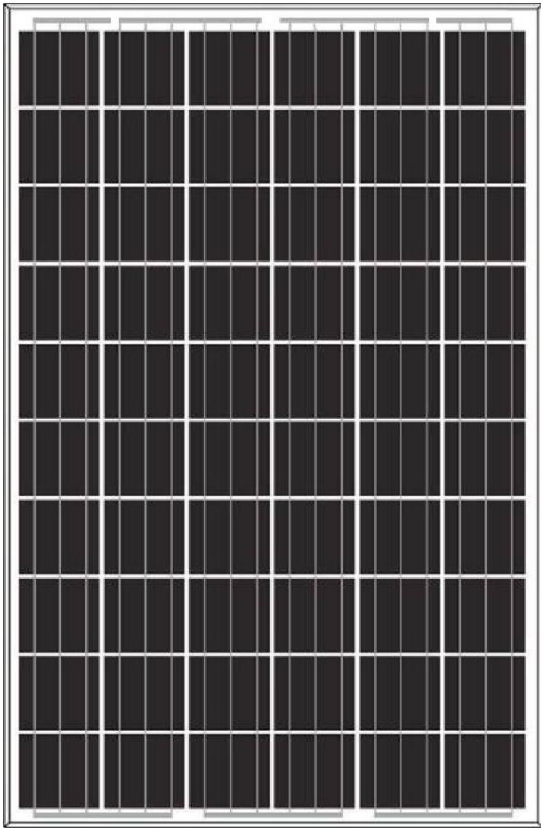

Quality & Long Lifetime: 10 year product guarantee of material and workmanship of Linuo Modules.



Warranty: Linuo offers linear power guarantee over 25 years for all modules.



Insurance: all guarantee items are covered by 25 year non-cancellable insurance for quality and performance--soalsafe.



Power Output: Linuo Modules are 100% plus tolerance by up to 5W.



Quality Control: More than 100 control points and test processes and 3 times 100% EL test.



TUV-Certificate: Linuo Modules fully match with DIN IEC 61215 und 61730 certification requirements.



Durability: Linuo Modules fully match with DIN IEC requirements on resistance against ammonia & salt mist corrosion.



Superior Performance: High performance and power output in low solar irradiation.



Stability: 5400 Pa Snow Load and 2400 Pa Wind Load fully matching with DIN IEC 61215 requirements.

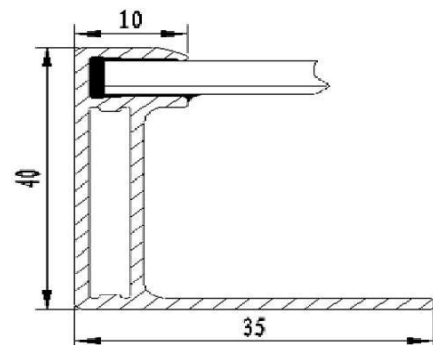
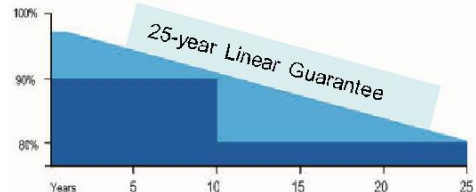

Power Output: Coating film on glass surface enable modules self cleaning function



Assurance: German Contract Partner and German law



Top-Ranking in STS Long-term Test - Linuo Module can fulfill all international standards.



Electrical Data

LN240(30)M-3-xxx(250-270W mono)

Pmax (W)	Uoc (V)	Isc (A)	Ump (V)	Imp (A)	FF	Module Efficiency	Max System Voltage	Max Series Fuse
250	38.19	8.81	30.38	8.23	74.31%	15.58%	1000V	15A
255	38.32	8.87	30.73	8.30	75.04%	15.89%	1000V	15A
260	38.44	8.93	31.07	8.37	75.76%	16.20%	1000V	15A
265	38.54	8.99	31.4	8.44	76.49%	16.52%	1000V	15A
270	38.7	9.04	31.77	8.50	77.19%	16.83%	1000V	15A

Temperature coefficient

Temperature Cycling Range	-40°C to +85°C
Nominal Operating Cell Temperature	48 °C
Temperature Coefficient of Isc:	0.063%/°C
Temperature Coefficient of Voc	-0.431%/°C
Temperature Coefficient of Pmax	-0.357%/°C

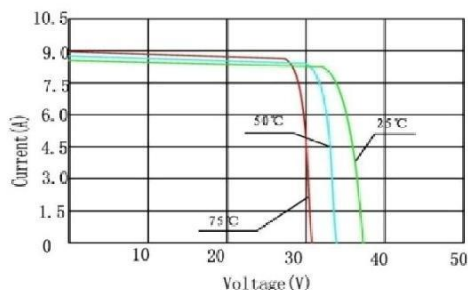

Mechanical Data

Module Dimension:	1634*982*40mm
Weight:	20.5kg
Mechanical Load:	5400 pa
Number of Cells:	60 pcs
Thickness of Glass:	3.2mm

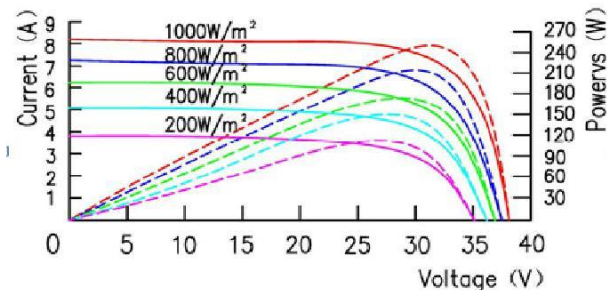

Guarantee

10-year product warranty (manufacturer guarantee)

For the general terms of 10-year product warranty on materials and workmanship of modules will be effective from the date of current contract.

25-year Power Output Warranty (Linear Guarantee)

In the first year of the warranty, the peak power of poly-crystalline module should be no less than 97.5% of the rated power (Pmax.) and 96.5% for mono-crystalline module. At the end of the 25th Year power of both types modules should be at least 80% of rated power. The annual decline in performance is 0.729% maximum for poly-crystalline modules and 0.68% for mono-crystalline modules.

STC (Standard Test Conditions): Irradiance 1000 W/m². Spectrum AM 1.5. Cell Temperature: 25 °C. NOCT(Nominal Operating Cell Temperature): Irradiance 800 W/m². Spectrum: AM 1.5. Environment Temperature: 20°C. Rated Operating Temperature: 48.2°C. Dimension: + / - 3 mm. Measurement Tolerances: + / - 3.5%. Data Tolerance: + / - 10% (except rated power). Technical Changes Reserved. All information without guarantee. Status: 12/2012. Please note that the output of black modules (All Black Type) can be reduced by up to 5% (per 1 °C increased of module temperature, the output drops by 0.5%). Please provide good ventilation condition.

